

Lenox Sound[®]

PORTABLE 5 INCH BLACK & WHITE TV

MODEL TV-504

OPERATING INSTRUCTIONS

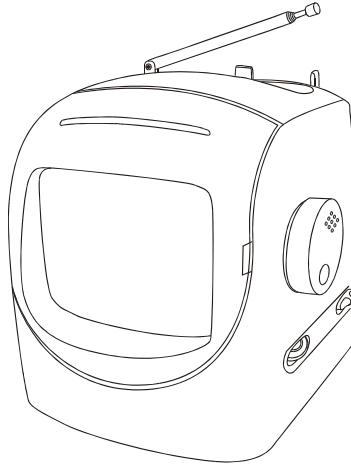

————— **USES 10 SIZE "C" BATTERIES (NOT INCLUDED)** —————

IB-TV504-E-V1

SAFETY INSTRUCTIONS



The lightning flash and arrow head within the triangle is a warning sign alerting you of "dangerous voltage" inside the product.

CAUTION

**RISK OF ELECTRIC SHOCK
DO NOT OPEN**

CAUTION: TO REDUCE THE RISK OF ELECTRIC SHOCK, DO NOT REMOVE COVER (OR BACK). NO USER SERVICEABLE PARTS INSIDE. REFER SERVICING TO QUALIFIED SERVICE PERSONNEL.



The exclamation point within the triangle is a warning sign alerting you of important instructions accompanying the product.

WARNING: TO REDUCE THE RISK OF FIRE OR ELECTRIC SHOCK, DO NOT EXPOSE THIS APPLIANCE TO RAIN OR MOISTURE.

THESE IMPORTANT SAFETY INSTRUCTIONS ARE INCLUDED, AS APPLICABLE TO THE APPLIANCE, CONVEYING TO THE USER THE INFORMATION ITEMIZED BELOW:

1. **Read Instructions** - All the safety and operating instructions should be read before the appliance is operated, and retained for future reference.
2. **Heed Warnings** - All warnings on the appliance and in the operating instructions should be adhered to.
3. **Water and Moisture** - The appliance should not be used near water - for example near a bathtub, washbowl, kitchen sink, laundry tub, in a wet basement, or near a swimming pool, and the like.
4. **Ventilation** - The appliance should be situated so that its location or position does not interfere with its proper ventilation.
5. **Heat** - The appliance should be situated away from heat sources such as radiators, heat registers, stoves, or other appliances (including amplifiers) that produce heat.
6. **Power Sources** - The appliance should be connected to a power supply only of the type described in the operating instructions or as marked on the appliance.
7. **Grounding or Polarization** - Precautions should be taken so that the grounding or polarization means of an appliance is not defeated.
8. **Power Cord Protection** - Power supply cords should be routed so that they are not likely to be walked on or pinched by items placed upon or against them, paying particular attention to cords at plugs, convenient receptacles, and the point where they exit from the appliance.
9. **Cleaning** - The appliance should be cleaned only as recommended by the manufacturer.
10. **Nonuse periods** - The power cord of the appliance should be unplugged from the outlet when left unused for a long period of time.

SAFETY INSTRUCTIONS

11. **Object and Liquid Entry** - Care should be taken so that objects do not fall and liquids are not spilled into the enclosure through openings.
12. **Damage Requiring Service** - The appliance should be serviced by qualified service personnel when:
 - A. The power supply cord or the plug has been damaged; or
 - B. Objects have fallen, or liquid has been spilled into the appliance; or
 - C. The appliance has been exposed to rain; or
 - D. The appliance does not appear to operate normally or exhibits a marked change in performance; or
 - E. The appliance has been dropped, or the enclosure damaged.
13. **Servicing** - The user should not attempt to service the appliance beyond that described in the operating instructions. All other servicing should be referred to qualified service personnel.
14. **Power lines** - An outdoor antenna should be located away from power lines.
15. **Outdoor Antenna Grounding** - If an outside antenna is connected to the TV receiver, be sure the antenna system is grounded so as to provide some protection against voltage surges and built up static charges. Section 810 of the National Electrical Code, ANSI/NFPA 70 provides information with respect to proper grounding of the mast and supporting structure, grounding of the lead-in wire to an antenna discharge unit, size of grounding conductors, location of antenna-discharge unit, connection to grounding electrodes, and requirements for the grounding electrode. See Figure.

EXAMPLE OF ANTENNA GROUNDING

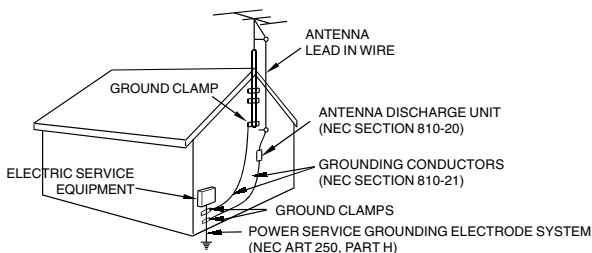

Do not apply oil or petroleum products or solvents to any part of this set.

BATTERY SAFETY INSTRUCTIONS

CAUTION: TO REDUCE THE RISK OF FIRE OR PERSONAL INJURY OR DAMAGE TO YOUR SET, READ AND FOLLOW THESE INSTRUCTIONS.

1. Use only the type and size of batteries mentioned in the operating instructions booklet (batteries are not included with this set, please buy the proper batteries).
2. Do not dispose the batteries into a fire. The cells may explode. Check with local codes for possible special disposal instructions.
3. Do not open or mutilate the batteries. Do not recharge non-rechargeable batteries.
4. Be careful when handling batteries in order not to short the battery with conducting materials such as rings, bracelets and keys. The battery or conductor may over heat and cause burns.
5. Do not attempt to rejuvenate the batteries identified for use with this product by heating them.
6. All batteries should be replaced at the same time. Mixing fresh and discharged batteries could increase internal cell pressure and rupture the batteries.
7. When inserting batteries into this product, the proper polarity (\oplus and \ominus) or direction must be observed.
8. Remove the batteries from this product if the product will not be used for a long period of time (several weeks or more).
9. Discard weak or dead batteries as soon as possible since they are more likely to leak in the product.
10. Do not store this product in high temperature areas.
11. If this product does not operate normally, or if the product is damaged, refer to the LENOXX WARRANTY INFORMATION. Opening or removing covers may expose you to dangerous voltages or other risks. Incorrect reassembly can cause electric shock when the appliance is subsequently used.
12. If liquid leaks from the batteries, carefully wipe this liquid. Do not allow it to touch your skin, and discard the leaking batteries.
13. Do not mix batteries (OLD and NEW or CARBON and ALKALINE, etc.).
14. The use of rechargeable batteries is not recommended for this set because their voltage and life is lower than standard batteries.
15. Installation of batteries should be done by an adult only.

LOCATION OF CONTROLS

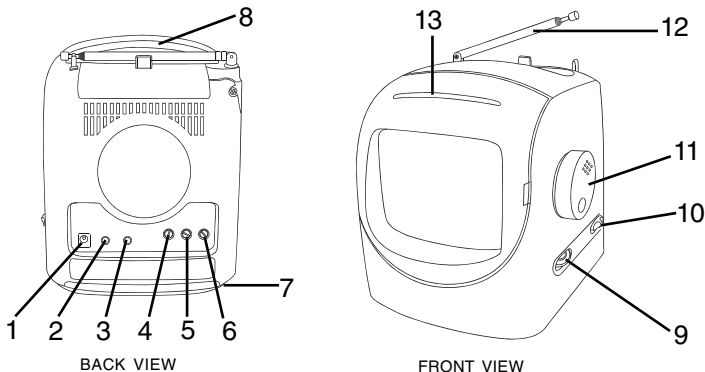

1. DC 12V POWER INPUT JACK - use for connecting AC or car adaptor
2. EARPHONE JACK - perfect for enjoying the TV program without disturbing others (plug earphone - not included - into this)
3. EXTERNAL ANTENNA JACK
4. CONTRAST CONTROL - adjust for suitable black and white contrast
5. BRIGHTNESS CONTROL - adjust for a brighter or darker picture
6. VERTICAL HOLD CONTROL - adjust this control if picture rolls up and down
7. BATTERIES COMPARTMENT - open from the bottom of the set
8. BUILT-IN CARRYING HANDLE
9. POWER & VOLUME CONTROL - switch the power ON or OFF, and adjust for desired sound level.
10. TV BAND SELECTOR - select VL, VH, or UHF band (depending on channel you want)
11. TUNING CONTROL - tunes into the channel you want to receive
12. TELESCOPING SWIVEL ANTENNA - extend for better reception
13. DIAL LENS - showing the station frequency

POWER SOURCES

You can choose different power sources for use at home, in a car, or as a portable.

1. Using AC Adaptor

Insert the supplied AC adaptor into the wall outlet, and the other end to the DC jack located at the rear of the TV.

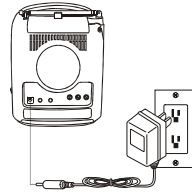

2. Using the TV in a Car

The DC jack is also used to connect to a car or boat cigarette lighter. Connect the car power adaptor (included) into the cigarette lighter socket of the car or boat (negative ground system only) and plug the other end into the DC jack located at the rear of the TV. Please refer to the next page for cautions on the car power adaptor.

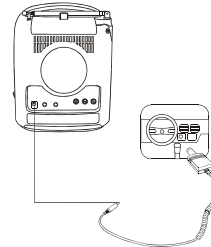

3. Using the TV on Batteries

Insert 10 size “C” batteries (not supplied) into the battery compartment (slide open from the bottom of the set and lift the door). Alkaline batteries are recommended for longer life.

To use the TV on batteries, disconnect the adaptor cord from the set.

When the batteries are not to be used for a long time, remove them to avoid damage that can be caused by battery leakage or corrosion.

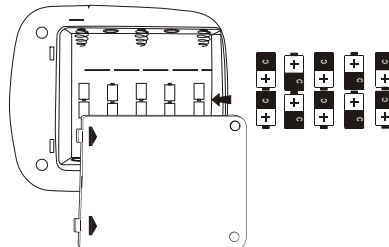

ANTENNA CONNECTION

1. Built-in Telescoping Antenna

In normal reception area, the built-in telescoping antenna will deliver a sharp clear picture. Extend the antenna to its full length and adjust the direction and angle for the clearest picture.

2. External Antenna Adaptor Pad (included)

Connect your external (roof) antenna to this adaptor and plug into the external antenna jack.

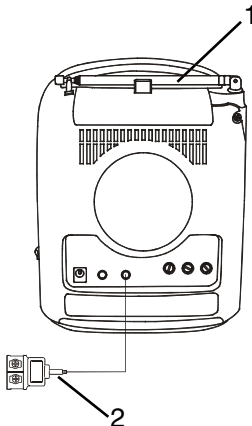

CAUTIONS ON THE CAR POWER ADAPTOR

- Use this set only with the supplied car power adaptor. Use with other ones could damage the set.
- When the inside of the cigarette lighter socket is dirty with ashes, the plug section may become hot due to poor contact. Be sure to clean your car cigarette lighter socket before use.
- After use, disconnect the car power adaptor plugs from both the set and the cigarette lighter socket.
- The car power adaptor may cause interference with reception to the car radio. If this happens, disconnect the car power adaptor from the cigarette lighter socket.
- Do not leave the car power adaptor plugged in without your car's motor running, your car's battery may be drained in some models of cars that supply power to the car power adaptor even with the car's key removed.

OPERATING ON TV

1. Selecting Band

Turn on the TV set by sliding the POWER switch to ON position. Then you may select a desired band by sliding the BAND selector to different positions:

VL: to select the VHF low channel TV broadcast stations (channels 2 to 6)

VH: to select the VHF high channel TV broadcast stations (channels 7 to 13)

UHF: to select the UHF all channel TV broadcast stations (channels 14 to 83)

2. Tuning into Desired Station

You may tune into a desired station by adjusting the TUNING control.

3. Adjusting for Best Picture

If the picture is too bright or too dark, adjust the BRIGHTNESS and CONTRAST controls (located on the rear of the unit).

4. Vertical Hold

If the picture rolls up and down, adjust the VERTICAL HOLD control on the rear of the unit.

5. Volume Level

You may adjust the VOLUME control to get the sound level you like.

USING A EARPHONE

You may enjoy your TV or radio sound without disturbing others by a mono earphone (not included).

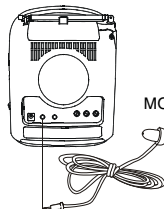

MONO EARPHONE

SPECIFICATION

TV SECTION

RECEIVER SYSTEM	: TV STANDARD SYSTEM FOR USA
TUNING RANGE	: ALL TV STANDARD CHANNELS - FROM 2 TO 83
ANTENNA INPUT IMPEDANCE	: 75 OHM INT. TELESCOPIC ANTENNA 300 OHM EXT. ANTENNA (USE ANTENNA PAD)
CRT	: 5 INCH DIAG.20 ϕ NECK 70 DEF
RESOLUTION	: MORE THAN 280 LINES
SOUND OUTPUT	: 0.25W
POWER	: 12V/850mA AC ADAPTOR (INCLUDED) 10 SIZE "C" BATTERIES (NOT INCLUDED) CAR CIGARETTE LIGHTER ADAPTOR (INCLUDED)

GENERAL

POWER CONSUMPTION	: 9.6W (DC 12V INPUT)
DIMENSION	: 6 1/2 x 7 1/2 x 7 inch
NET WEIGHT	: 4 LBs (APPROX.)
GROSS WEIGHT	: 5.5 LBs (APPROX.)
ACCESSORIES	: CAR POWER CORD AC ADAPTOR EXTERNAL ANTENNA ADAPTOR (PAD)

LENOXX reserves the right to make design and specification changes for product improvement.

PROTECT YOUR FINE FURNITURE!

We recommend a cloth or other protective material be placed under the set when placing it on surface with a natural or lacquer finish.

LIMITED WARRANTY

We warrant this product to be free from defects in material and workmanship under normal use for a period of 90 days after purchase and we will repair it free of charge or replace it at no charge, should it become defective under this warranty, providing you submit proof of purchase (sales slip) with the set.

During the initial 90 day period after original purchase, we will service or exchange, at no charge, the set that is returned to LENOXX ELECTRONICS CORP. After the initial 90 day period expires, and for a period of 12 months from original purchase, we will repair the unit covering any part(s) that need to be replaced at no charge, but will charge for the cost of labor, return postage paid by LENOXX.

This warranty does not apply to any products which have been subject to misuse, neglect or accident. This warranty does not cover broken headphones or cabinet. UNDER NO CIRCUMSTANCES WILL LENOXX ELECTRONICS CORP. BE LIABLE FOR ANY INCIDENTAL OR CONSEQUENTIAL DAMAGES. Some states do not allow the exclusion or limitation of incidental or consequential damages, so the above limitations or exclusions may not apply to you.

This warranty gives you specific legal rights, and you may also have other rights which vary from state to state. The following charges apply to repairs beyond the warranty period: \$15.00. Be sure to pack carefully and return postage paid insured together with your money order (personal checks will not be accepted) and sales receipt to :

LENOXX ELECTRONICS CORP.
2 GERMAK DRIVE, CARTERET N.J. 07008

© 2001 LENOXX ELECTRONICS CORP.
2 GERMAK DRIVE,
CARTERET, N.J. 07008
MADE & PRINTED IN CHINA